

Dual

OWNER'S MANUAL

DUAL 1015
AUTO/PROFESSIONAL
TURNTABLE

OPERATING INSTRUCTIONS

Needless to say, we are delighted that you have chosen the Dual 1015. Now, like most new owners, you are probably eager to get set up and play your first record. This won't take long, but it is important that you read the installation instructions carefully (on the inside of this flap). We also suggest you familiarize yourself with the 1015's many operating features as described on the following pages. Each of them is a typical example of Dual's advanced technology. Pleasant listening!

Master Operating Switch

This *one* feather-touch slide switch controls all operating functions, in both single play and changer operation, as described below.

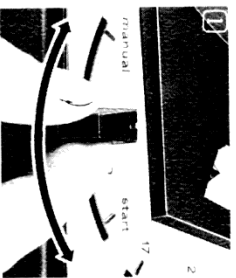

For automatic start, you move it past STOP to START: For automatic stop, move it to STOP. To start the platter rotating without putting the tonearm into cycle, move to MANUAL after lifting tonearm from resting post and moving it toward the center.

Preparations for Play

Select the correct speed and record indexing size for the record to be played, then insert either the short spindle (for single play) or the Elevator-Action spindle (for changer operation).

Single Play

1. **Automatic Start:** move the slide switch to START.

2. **Automatic Start with Cue-Control:** First move Cue-Control to position , then move slide switch to START. (This provides an even more gradual tonearm descent, as sometimes preferred for ultra high compliance cartridges.)

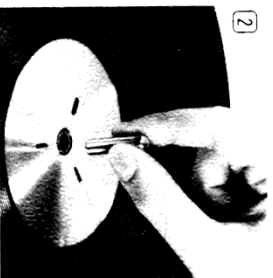

3. Manual Start (on rotating record):

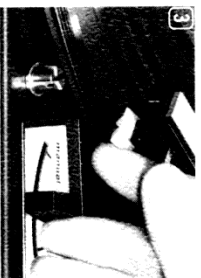

- Lift tonearm and move switch to MANUAL. (This can easily be done as shown in fig. 3.)
- Place tonearm on record.



4. Manual Start (on motionless record):

- Place tonearm on record.
- Move switch to MANUAL.

5. Cue-Control Start (on rotating record):

- Move Cue-Control to position .
- Place tonearm over lead-in groove (or over any other groove).
- Move switch to MANUAL.
- Flick Cue-Control to position .

6. Cue-Control Start (on motionless record):

Same as 5, but reverse steps d and c.

- To stop play:** (tonearm returns to rest, motor shuts off)
Push to STOP.

8. To interrupt play and replay from beginning:

Push gently to STOP, pause, then continue to START.

- To interrupt play:** (when play is to be resumed where interrupted).
Move Cue-Control to position .

- To resume play:**
Flick Cue-Control to position .

NOTE: at the end of play, the tonearm will return to its resting post and the entire machine will shut off automatically.

Automatic Changer Operation

Insert the changer spindle by placing the key at its base into the slot of the shaft. Then turn the spindle clockwise *until it stops*. Up to ten records can be placed on the spindle.

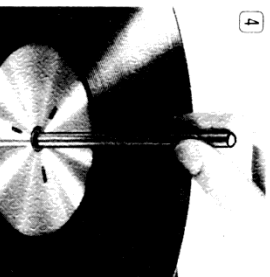

All the functions for single play, as described above, are exactly the same in changer operation, plus these additional functions:

- To reject a record during play and change to the next record on the spindle:**

Push gently to STOP, pause, then continue to START.

2. To skip the next record on the spindle:

Push to STOP. After that record drops, push to START and the next record will drop.

NOTE: Any record already on the platter, can be replayed either automatically or manually, just as with the single play spindle. If there are any records on top of the one you wish to replay, simply lift them back onto the platform or off the spindle. (The 3-pronged platform will retract into the spindle as the records slip past.) No need to remove the spindle itself.

Jamproof Tonearm

During either single play or changer operation, the tonearm can be lifted from the record, moved and placed down again either by hand or by the Cue-Control. The tonearm may even be restrained during cycling without causing any malfunction... thanks to its foolproof slip-clutch.

INSTALLATION INSTRUCTIONS

Installation on Base or Mounting Board*

Required dimensions: 12 $\frac{3}{4}$ " width; 10 $\frac{3}{4}$ " depth, 6 $\frac{1}{2}$ " height above mounting board, 3" below.

These ingeniously designed mounting screws make it possible to install and remove your Dual from either base or mounting board entirely from the top. There's no need to fumble underneath or to take anything apart.

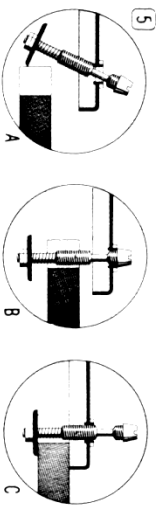

1. Position the chassis over the base so that the three cupped spring-mounted footings will fit into their cut-outs. (The notch on the base for the rear top/mount spring screw will then be at the upper left.) Tilt both mounting screws to let them slip past the notches as you lower the chassis. (Fig. 5A)
2. Turn each screw clockwise until it is firmly seated into the top of the chassis. (Fig. 5B) That's all there is to it. To remove the Dual, simply reverse the above procedure.

To Transport the Dual Without Demounting

1. Loosen both top/mount spring screws, depress the chassis against the base, then continue to turn each screw counter-clockwise until it stops. The chassis will then be locked firmly against the base. (Fig. 5C)
2. To avoid possible damage to the platter bearings in transit, insert the plastic wedges (supplied in the accessory bag) between the platter and chassis. Position the wedges at equal distances for maximum support. Or you can remove the platter from the chassis (See below).

Mounting the Cartridge*

NOTE: Any cartridge weighing between 1 and 8 grams and meeting standard U.S. mounting specifications can be used with the Dual 1015. For cartridges weighing up to 14 grams, order supplementary counterbalance 12P-U-115.

1. Release the cartridge holder from the tonearm head by pressing the tonearm lift a short turn to the rear. Be ready to catch the holder, as it will drop right into your hand (Fig. 10).

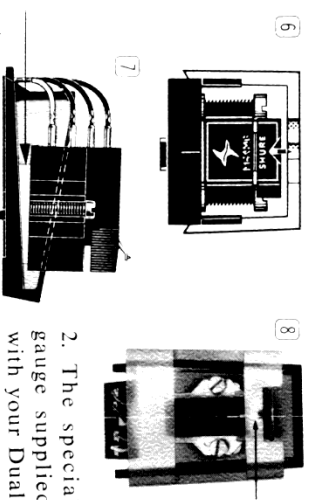

2. The special gauge supplied with your Dual, when snapped on to the holder as shown in fig. 6, will indicate the correct stylus depth for the cartridge when mounted. (Be sure the ridges on the inside of the gauge walls fit into the corresponding tracks on the side of the cartridge holder.)

When the cartridge is mounted at the correct depth, the tip of the stylus will protrude slightly into the notch of the gauge. (Use the necessary spacers and screws provided in the accessory bag.)

3. The specially tapered wedge, also supplied, is for use when you intend to play single records either exclusively or primarily. (Fig. 7) This wedge provides the optimum 15° vertical tracking angle when one record is on the platter. (However, even without the wedge, the vertical tracking angle will still be well within standard industry tolerances for single record play.)
4. Remove the gauge when actually mounting the

cartridge, then snap it on again — carefully — to check stylus overhang. When viewed from the top (Fig. 8), the stylus should be centered within the notch of the gauge.

5. Finally, tighten screws, making sure cartridge is positioned straight. Note dotted line in fig. 8.
6. Connect each lead on the cartridge holder to its corresponding pin on the cartridge. Each lead is color-coded as shown in fig. 9.

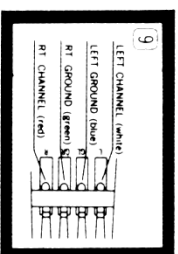

7. Attach the cartridge holder by placing it against the tonearm head as shown in fig. 10, lift it up and lock it by pressing the tonearm lift forward.

Balancing the Tonearm*

1. To prepare the tonearm for balancing, first make sure it is disengaged from the cycling mechanism. Before connecting the unit to power supply, and with tonearm locked on its resting post, slide operating switch to "start" and rotate platter by hand until switch returns to "neutral."

2. Set stylus force adjust **11** and Tracking Balance Control **15** to 0.

3. Loosen inner lock screw **13** of the counterbalance adjustment **12** by turning it slightly to the left. (As shown in fig. 11, a coin is all that's needed.)

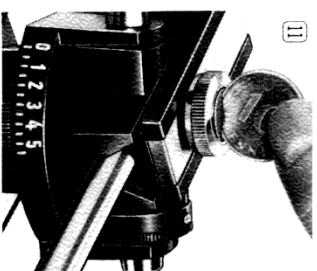

*Instructions for installing on base, mounting cartridge and balancing tonearm apply for Duals purchased as separate components. If your Dual is already mounted within a console, these installation procedures have already been made for you. However, reading these three sections will help familiarize you with the unit.

4. Unlock tonearm, lift it off its resting post and turn counterbalance adjustment until tonearm is balanced and floats horizontally. (Turning adjustment to left raises tonearm head, turning to right lowers it.)

The tonearm will be perfectly balanced when edges A on the

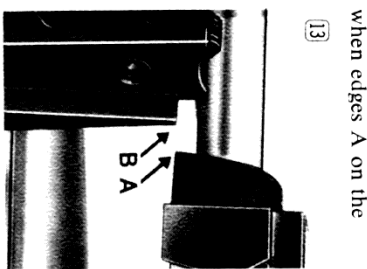
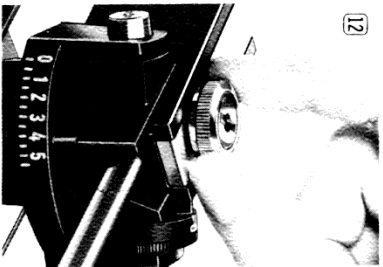

tonearm head and B are lined up as shown in fig. 13. (Perfect balance is, of course, especially important with very light tracking.)

5. Tighten the inner lock screw, taking care not to move the counterbalance adjustment knob.

NOTE: This procedure needs to be repeated only when a new cartridge of a different weight is to be used.

Applying Stylus Force

Once the tonearm is balanced at zero, you simply dial the stylus force. The number on the direct-reading dial **14** is accurate to within 0.1 gram. The instructions accompanying your cartridge will give you the range of minimum and maximum tracking forces its manufacturer suggests.

As the tonearm of the Dual 1015 can track flawlessly as low as 1/2 gram, the only limitations on

tracking are those imposed by the cartridge itself. That is why you can use any cartridge you prefer, including those with ultra-high compliance styli not ordinarily recommended for use in automatic tonearms.

Applying Tracking-Balance Control

The Dual 1015 is designed to provide continuously variable Tracking-Balance Control. (See page 6 for full explanation.)

To apply Tracking-Balance Control for the tracking force you have set for your cartridge, simply rotate the Tracking-Balance dial **15** to the same number as on the stylus force dial.

Connection to Amplifier (or other audio equipment)

The red phono cable is for the left channel, the yellow cable for the right channel. Connect to your amplifier or other audio equipment according to their instructions.

Connection to Power Supply

AC voltage and line frequency (cycle) requirements are indicated on both the outside of the carton and on top of the chassis beneath the turntable platter. Check before connecting to power supply.

Note to servicemen: The Dual can be set for either 110 VAC or 220 VAC. It can also be used with line frequency of either 50 or 60 cycles. The 60 cycle pulley is Part Number 31-N-U54; the 50 cycle pulley is Part Number 31-N-U45.

Adjustment for Lead-In Groove

The Dual's tonearm has been carefully set at the factory to set down accurately in the lead-in groove during automatic start. However, the dimensions of some cartridges may cause the stylus to set down either too far in or too far out. The necessary adjustment can be made quite simply as follows:

1. Move record-size selector switch to 7" position. This will expose the adjustment screw **5** through the opening in the chassis near the tonearm post.

2. If the stylus had touched down outside the lead-in grooves, turn the screw clockwise (very slightly). If the stylus had touched down on the recorded grooves, turn the screw counter-clockwise.

(Although it is most convenient to use a 7" record, any size record can be used to make and check the adjustment, as once the tonearm has been correctly set for one size record, it will be correct for all. Set the size selector switch back for the record size you're using if you don't have a 7" record.)

Removing the Platter

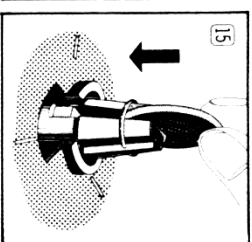
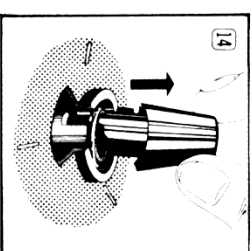

The platter is secured to the chassis by a spring-clip around the groove of the shaft. To remove the platter, first lift off the decorative metal disc affixed to the mat by a pressure-sensitive adhesive.

Using the special accessory cone supplied in the bag with the cartridge mounting hardware, remove the spring-clip (Fig. 14). Then lift the platter slowly and gently off the shaft. Avoid touching the inner surfaces with your fingers, as skin oils can induce slippage.

Reverse these procedures when replacing the platter. The same accessory is used to secure it with the spring-clip. As shown in fig. 15, press the spring-clip all the way down with the use of a coin until it is again seated in the groove.

The decorative metal disc can now be replaced by lining up the three slots with the three matching ridges on the mat. The self-adhesive will hold it.

DUAL 1015 AUTO/PROFESSIONAL TURNTABLE

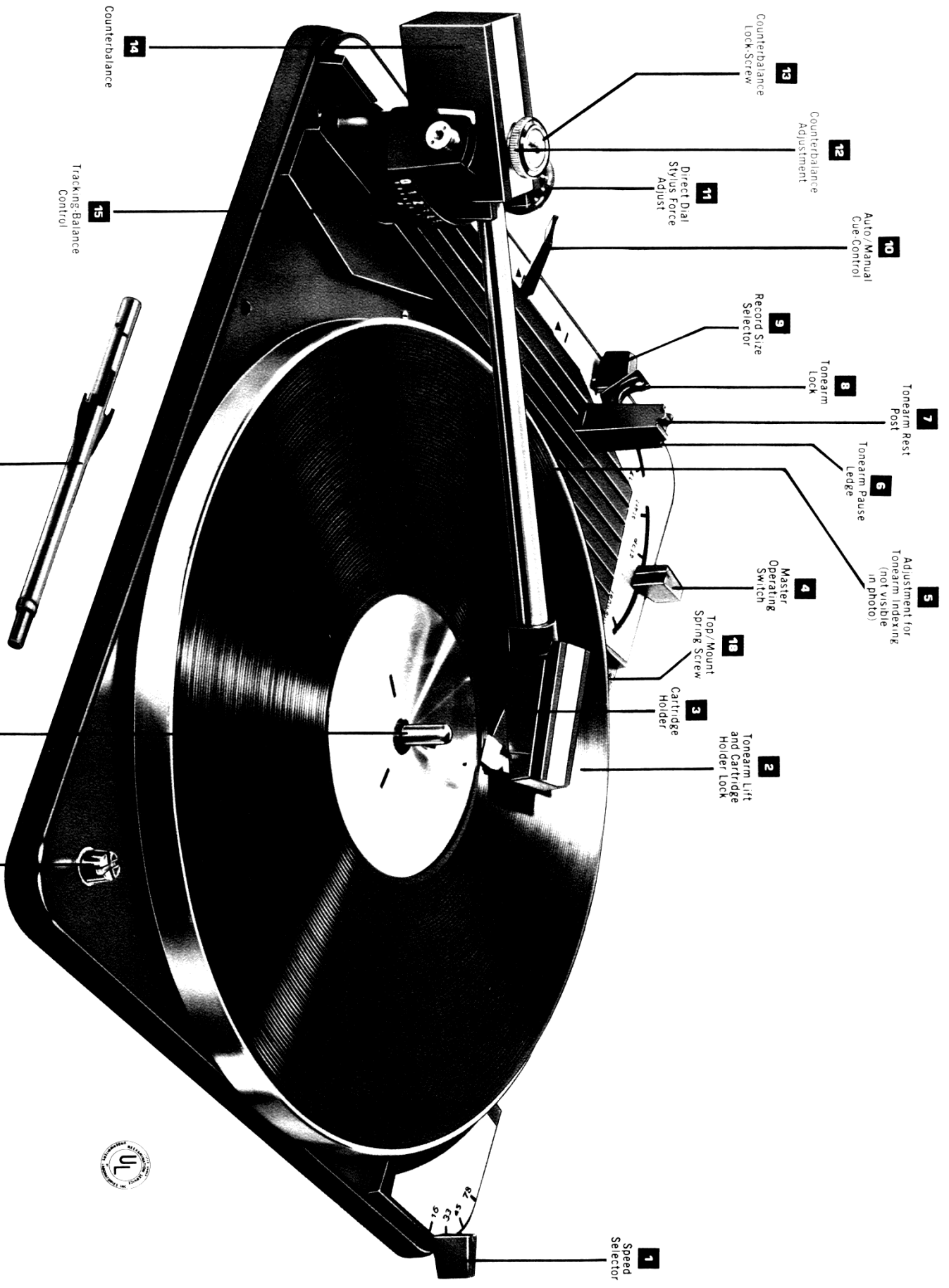

1 Speed Selector

13 Counterbalance Lock-Screw

12 Counterbalance Adjustment

11 Direct Dial Stylus Force Adjust

10 Auto/Manual Cue-Control

9 Record Size Selector

8 Tonearm Lock

7 Tonearm Rest Post

6 Tonearm Pause Ledge

4 Master Operating Switch

5 Adjustment for Tonearm Indexing (not visible in photo)

18 Top/Mount Spring Screw

3 Carriage Holder

2 Tonearm Lift and Carriage Holder Lock

14 Counterbalance

15 Tracking-Balance Control

16 Changer Spindle

17 Single Play Spindle

18 Top/Mount Spring Screw

CONTINUOUSLY VARIABLE, DIRECT-DIAL TRACKING-BALANCE CONTROL™ (Anti-Skating)

What You Should Know About Skating

Skating refers to the side-thrust imparted to the stylus from the offset angle of the tonearm head and the friction between the stylus and the rotating record.

This causes the stylus to "skate" toward the center of the record, thus causing increased force against the inner groove and correspondingly less force against the outer groove. This results in distortion, increased wear on the inner groove and uneven wear on the stylus itself.

Skating is actually not a serious problem with ordinary tonearms, as their bearing friction in the pivot is generally high enough to cancel out or minimize the tendency to skate. Of course, bearing friction high enough to prevent skating is also high enough to compromise tracking performance at the ultra-lightweight forces now made possible by today's finest high compliance cartridges.

Actual Forces Present at Stylus Point

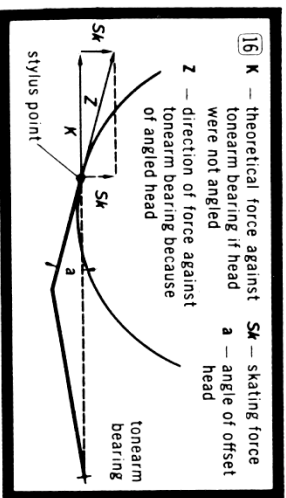

The amount of skating force is directly measurable, and amounts to about 12% of tracking force. Fig. 16 illustrates the physical principle behind skating and the forces that cause it.

A tonearm with 2 gram tracking force will thus have a potential skating force of .24 grams. We say *potential*, since, as noted above, if a tonearm's bearing friction is above .24 gram, it won't skate. The bearing friction of the Dual 1015 tonearm, on the other hand, is lower than 0.04 gram. Thus, Tracking-Balance Control of the same high order of precision—and with continuously variable control—was one of the major goals and achievements of the 1015's design.

Applying Tracking-Balance Control



Just as you set stylus force on the Dual with a continuously variable direct-reading dial, so do you set Tracking-Balance Control for that same force (Fig. 17).

Tracking Force	Tracking-Balance Control for Stylus Radii (in mils)								elliptical 0.2x0.9
	0.4	0.5	0.6	0.7	0.8				
0.5	0.70	0.60	0.50	0.50	0.45			0.85	
1.0	1.25	1.15	1.00	0.95	0.90			1.50	
1.5	1.80	1.60	1.50	1.45	1.40			2.10	
2.0	2.30	2.10	2.00	1.95	1.90			2.70	
2.5	2.90	2.60	2.50	2.45	2.40			3.40	
3.0	3.50	3.10	3.00	2.90	2.85			4.20	
3.5	4.10	3.65	3.50	3.40	3.35				
4.0	4.75	4.25	4.00	3.90	3.85				
4.5	4.75	4.50	4.35	4.35	4.30				
5.0		5.35	5.00	4.85	4.75				

As shown by the bold-face numerals in the chart, Tracking-Balance Control is calibrated for the most commonly used round stylus radius (0.6 mil). This calibration is also sufficiently accurate for other stylus radii as well.

What's more, for the perfectionist who wishes to take the fullest possible advantage of the precision Tracking-Balance Control now made possible, the other columns indicate the adjustment to be made for other radii from 0.4 mil to 0.9 mil, as well as the elliptical stylus (0.2 mil x 0.9 mil).

This means that for the first time you can *actually balance stylus force on both walls of the stereo groove!*

All this is one more example of how Dual assures you of the best possible performance from any cartridge/stylus combination.

AUTO/MANUAL CUE-CONTROL™

Precise Stylus-to-Groove Cueing

With the Auto/Manual Cue-Control, still another measure of flexibility and precision has been added to the unrestricted automatic and manual play that has long been available in all Dual automatic turntables.



The Cue-Control makes it possible to pre-position the stylus over any groove and then lower it with absolute accuracy into that very same groove. You can also play to any point, interrupt with the Cue-Control, and resume play where you left off.

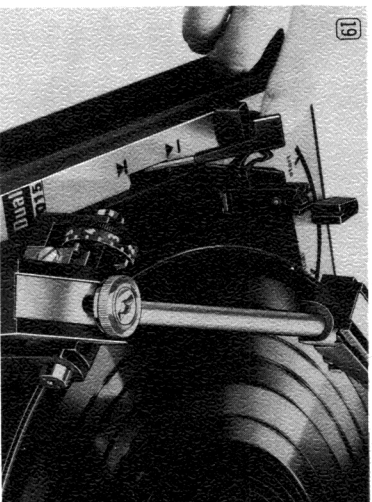

A close look at the stylus as it descends will show how the vertical piston action of the Cue-Control mechanism lowers the tonearm with no side-shift whatever, regardless of portion of the record being played.

You will also notice how the silicon damping slows the descent of the tonearm . . . a far more gentle descent than would ever be possible by hand.

Using the Cue-Control





The Cue-Control has two positions:  to lift the tonearm, and  for lowering it. (Fig. 19) To lower the tonearm to any groove, you need give only the lightest flick to the Cue-Control. The descent of the tonearm is immediately taken over by silicon damping and a piston action. Lowering speed is 0.5 cm/second, and is unaffected by temperature or humidity changes.

To raise the tonearm, on the other hand, you do control the rate of ascent by the speed with which you move the Cue-Control from position  to position .

With Automatic Start Too!

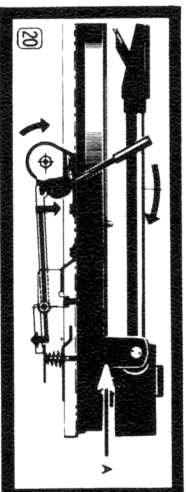
The Cue-Control can also be used together with automatic start for a slower-than-normal rate of descent, as may be desired with ultra-high compliance styli. Once the cycling action has placed the tonearm over the 'lead-in groove and it begins to descend, then Cue-Control takes over. The Cue-Control itself is automatically shifted to position , where it is ready to raise the tonearm at any time during play.



Cue-Control is shown at position , with tonearm supported by piston (A). When Cue-Control is shifted to position , the piston is released and permits tonearm to slowly lower to record. At this point, the tonearm is completely disengaged from the Cue-Control.

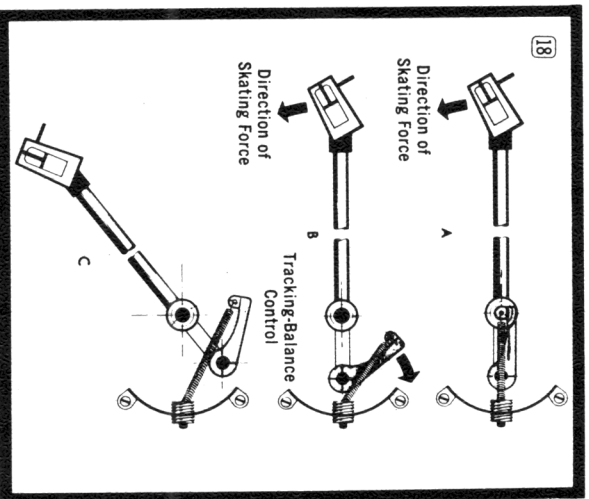

These illustrations show how Tracking-Balance Control is applied within the tonearm system of the Dual 1015. (A) No Tracking-Balance Control applied. (B) Tracking-Balance Control applied by special non-fatiguing springs. Tonearm in rest position. (C) Tonearm now in extreme center position. Though spring is extended, Tracking-Balance Control remains constant through the entire area of tonearm travel, due to angle which correspondingly reduces pull of the spring.

DYNAMICALLY BALANCED TONEARM WITH DIRECT-DIAL STYLUS FORCE ADJUST

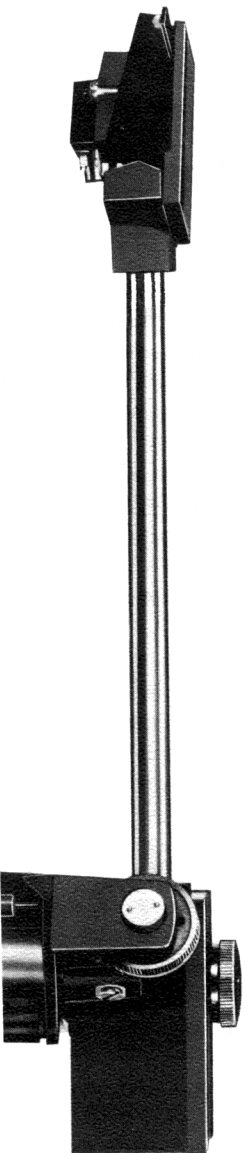

Flawless Tracking as Low as 1/2 Gram

Not all so-called "dynamically balanced" tonearms actually measure up to that important qualification, as dynamic balance requires that the tonearm's integral mass remain balanced at all times when tracking.

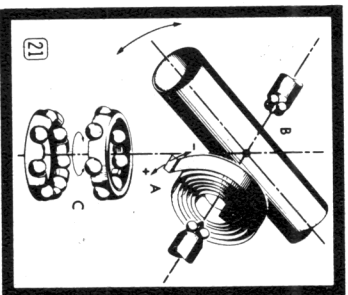

This tonearm maintains its true dynamic balance in all planes because tracking force is applied at the pivot point by a long, multiple-coiled main-spring (Fig. 21A). The weight of the tonearm itself remains in constant balance.

Friction-Free Pivots

The Dual 1015's tonearm pivot is virtually friction-free (less than 0.04 gram) in both vertical and horizontal planes. For its vertical movement, the tonearm is pivoted on two hardened steel

points, each supported by precision ball bearings. (Fig. 21B) In the horizontal movement, double ball bearing units are used (Fig. 21C).

Direct-Dial Stylus Force

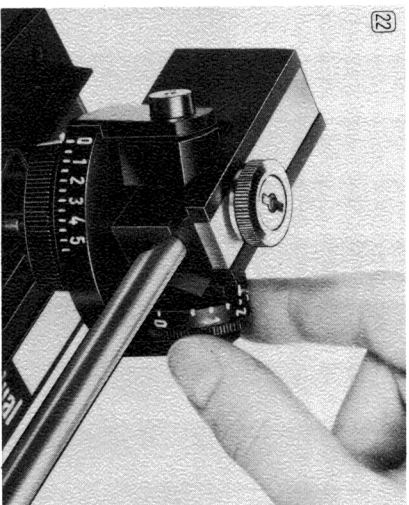

Tracking force is applied with the same order of precision as used in balancing the tonearm. The continuously variable adjustment (from 0 grams up) is also essential with ultra-lightweight tracking. The readings on the dial (Fig. 22) are accurate to within 0.1 gram.

"At-Home" Demonstration of Tonearm Balance, Tracking and Low Bearing Friction

Among the final "torture" tests that each Dual 1015 must pass at the factory are some which you can easily duplicate at home. We believe that you will find them both interesting and impressive demonstrations of the precision tracking possible with this truly remarkable instrument.

Featherlight Tripping

The tripping action is accomplished by a lightweight glider which rides freely on a ball bearing toward the center as the tonearm approaches the run-out grooves. When the stylus reaches these grooves, the glider is brought into featherlight contact with the free-suspension trip switch, and the automatic trip immediately takes over. Less than 0.4 gram force is sufficient to activate the switch.

Tripping at 1/2 Gram

If you have a high compliance cartridge and a new record with smooth run-out grooves you can witness the phenomenon of a tonearm actually tripping at 1/2 gram! Just set the stylus force scale accordingly, and place the tonearm on the record near the center, just outside the run-out groove. Then press the slide switch to MANUAL and watch the effortless tripping performance.

Tripping at "Zero"

Try this also. With the stylus force scale set at 0, allow the tonearm to float over the record in mid-air. Push to MANUAL to rotate the record, then blow gently on the tonearm from the side . . . just enough

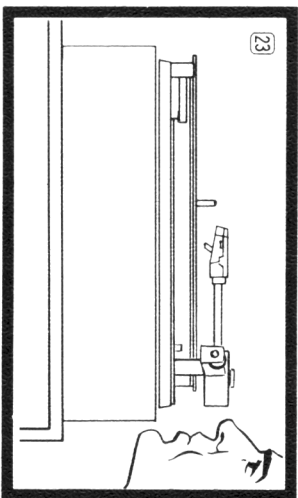

to ease it toward the center. (Fig. 23) As your breath alone moves the tonearm, it will again trip and then float gently back. (Because it is set at 0 tracking force, the tonearm will not descend to its resting post. So be sure to restore the normal tracking force for your cartridge.)

Tonearm Balance

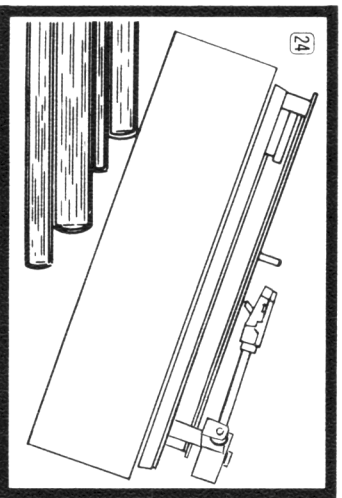

With a 12" 33-rpm record on the platter and the stylus force set at 1 gram, prop the Dual up as shown in Fig. 24* at any angle up to 60°. When you push to START, the tonearm will index and

track flawlessly, as a demonstration of its perfect balance in all planes. (While tracking, the Dual can be tilted even further to almost 90°.)

Vertical and Horizontal Movement

Now, without tilting the Dual itself, place a cigarette or short pencil between the record and platter to simulate the effect of a badly warped record. Again, the tonearm will track flawlessly, this time as a demonstration of the low friction in the vertical pivot.

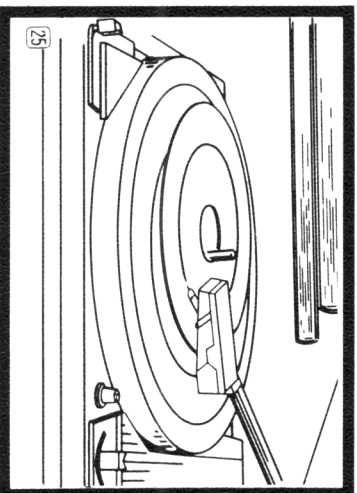

Finally, for the "piece de resistance," test for low friction in the horizontal pivot. To do this, place a large-hole 7" record on the platter, but off center. (Fig. 25) Place the tonearm on the lead-in groove and push to MANUAL. The sight of the tonearm swaying back and forth while tracking is indeed startling.

*You can actually tilt the Dual from any side except the right, as the free action of the trip switch would then cause it to be activated at about 20° tilt. Needless to say, the Dual requires no leveling.

ACOUSTIC FEEDBACK ELIMINATED

The only vibrations induced upon the stylus should be those originating from the recorded grooves. Any others, such as those present in the speakers, must be isolated from the stylus, or it will repeatedly transmit those spurious signals throughout the system — as "acoustic feedback."

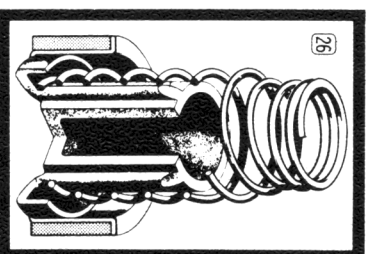

Dual has taken extraordinary care in eliminating anything that would tend to induce acoustic feedback. For example, the spring-mounted footings (Fig. 26) are internally cushioned with rubber between spring and caps. Further, the springs themselves are "soft," because the feather-touch side-to-side action of the operating slide switches do not require stiff vertical resistance.

The tonearm counterbalance is also rubber-isolated from its shaft, as you will notice when handling it. And the motor, of course, is thoroughly insulated against both shock and vibration. These are some of the "inside" reasons why you will find Dual automatic turntables in the highest quality single-cabinet consoles that can reproduce the full frequency response range without concern for acoustic feedback.

ELEVATOR ACTION™ CHANGER SPINDLE

The Elevator-Action changer spindle, which holds up to ten records offers another exclusive Dual feature that protects your records against any possible damage such as may occur from the use of pusher arm mechanisms or offset spindles.

Fig. 27 illustrates the four steps of the Elevator-Action. First, the entire stack rests upon a three-pronged platform (a). When the slide switch is pushed to START, the weight of the entire stack is lifted off the bottom record (b), which is then released to descend to the turntable (c). The stack now lowers (d) to await the next change cycle.

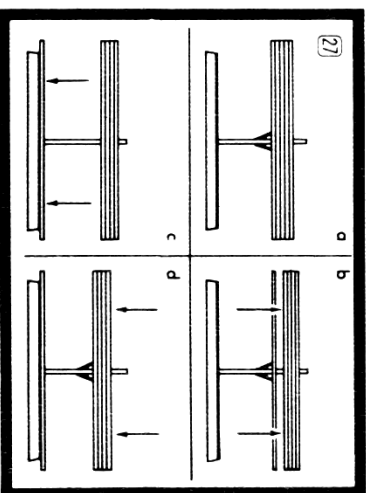

This method is foolproof with all records that conform to the international standards of the record industry as to the size and concentricity of the center hole. (On rare occasions when a record does

not drop properly, it is most likely due to excess label paper extending into the record hole, which should be clean.)

POWERFUL, CONSTANT SPEED HI-TORQUE™ MOTOR



Of entirely new design, the Dual's powerful and utterly quiet Hi-Torque motor effortlessly brings the heavy turntable to full speed virtually instantaneously. The rotor is dynamically balanced in both planes. Together with the evenly and precisely distributed poles, this eliminates at the source, one of the major sources of rumble and assures speed constancy.

All four speeds are accurate within 0.1%, with one to ten records. Further, voltage variations can exceed $\pm 10\%$ with no effect on speed whatever! Thus the Hi-Torque motor combines the advantages of the induction and synchronous motors.

Power Control for Amplifier Shut-off

Your Dual 1015 is equipped with a unique provision for controlling the power to the amplifier, so that the entire system can be switched on and off automatically by the turntable. To take advantage of this special feature (which handles up to 3 amps), consult your Dual dealer or a qualified serviceman, in accordance with UL requirements. When used with a receiver, we suggest an external on-off switch be included, so that the tuner section can be used without operating the turntable.

Servicing

If your Dual 1015 ever requires servicing, either take it to your Dual audio dealer, or ask him for the address of the nearest Authorized Dual Service Station. Be sure that authentic Dual parts are used whenever replacement is necessary. *Always ship the Dual in its original packaging, or if it has been discarded, write for special shipping instructions.*

For correspondence only:

UNITED AUDIO PRODUCTS, INC.
535 Madison Avenue, New York, N. Y. 10022

For shipment of merchandise:
UNITED AUDIO PRODUCTS, INC.
56-08 37th Avenue, Woodside, N. Y. 11377